

M6x1 ISO - HTAP ▾ .15-000
5 DRILL (5+000) ▾ 20.000 - (6) HOLE

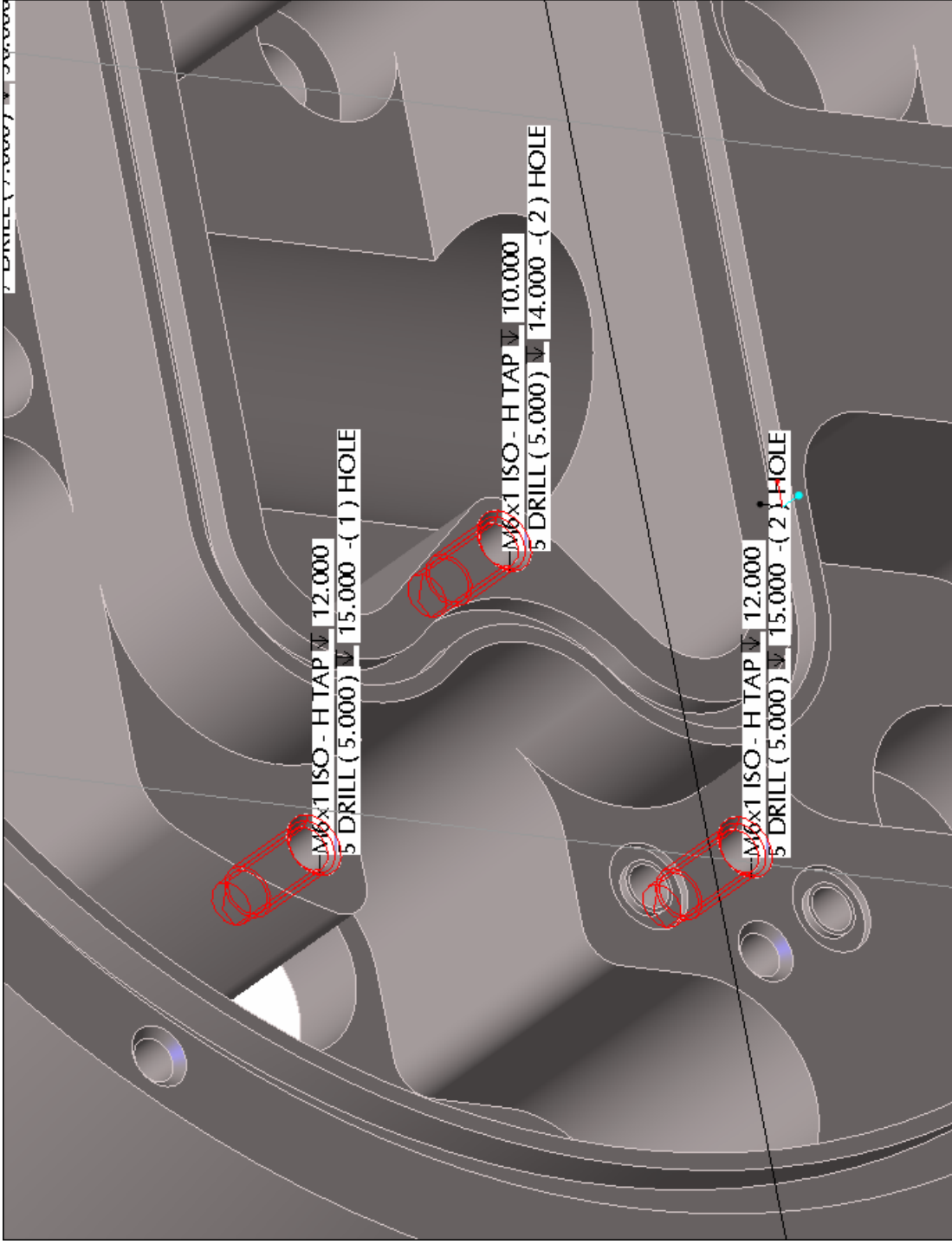

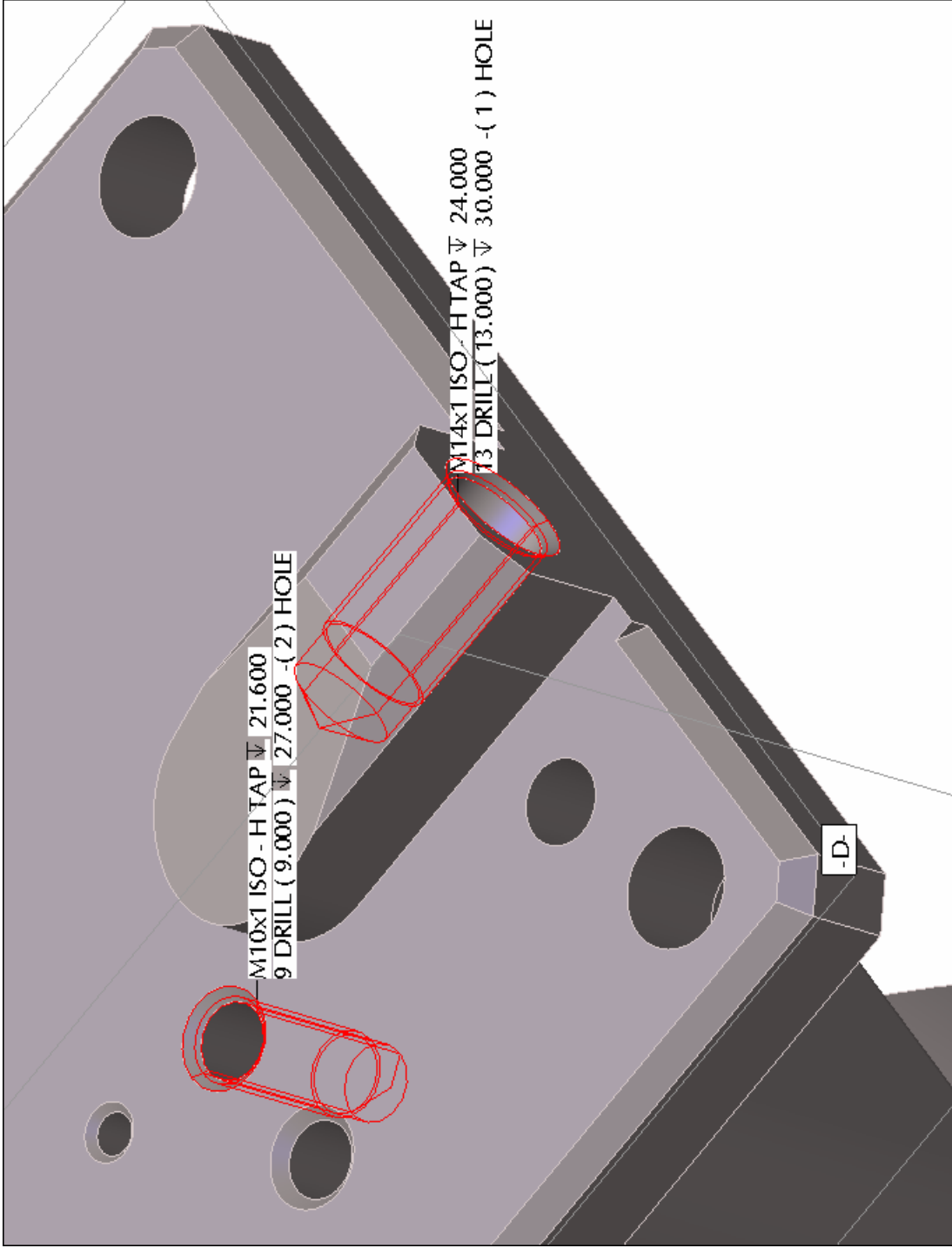

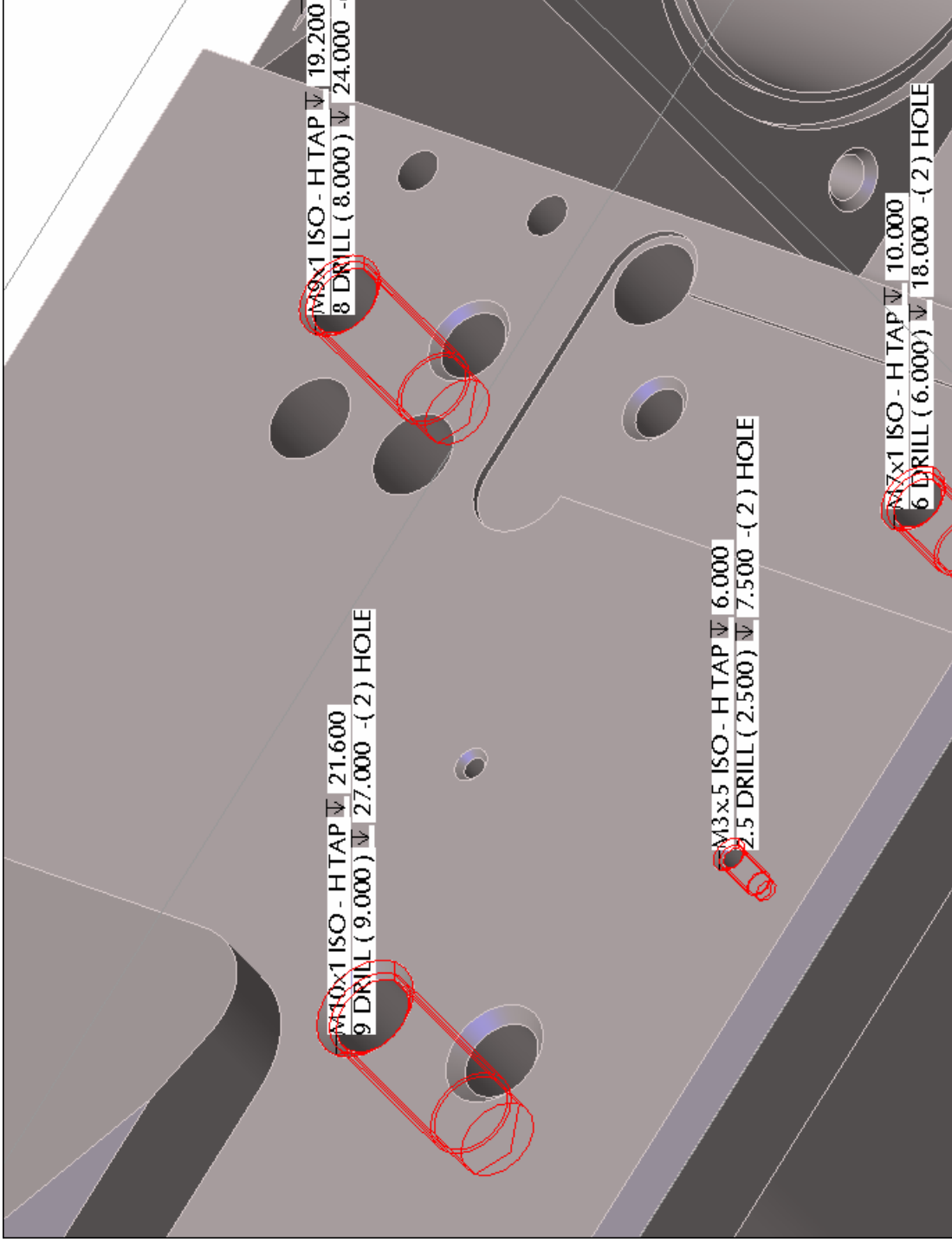

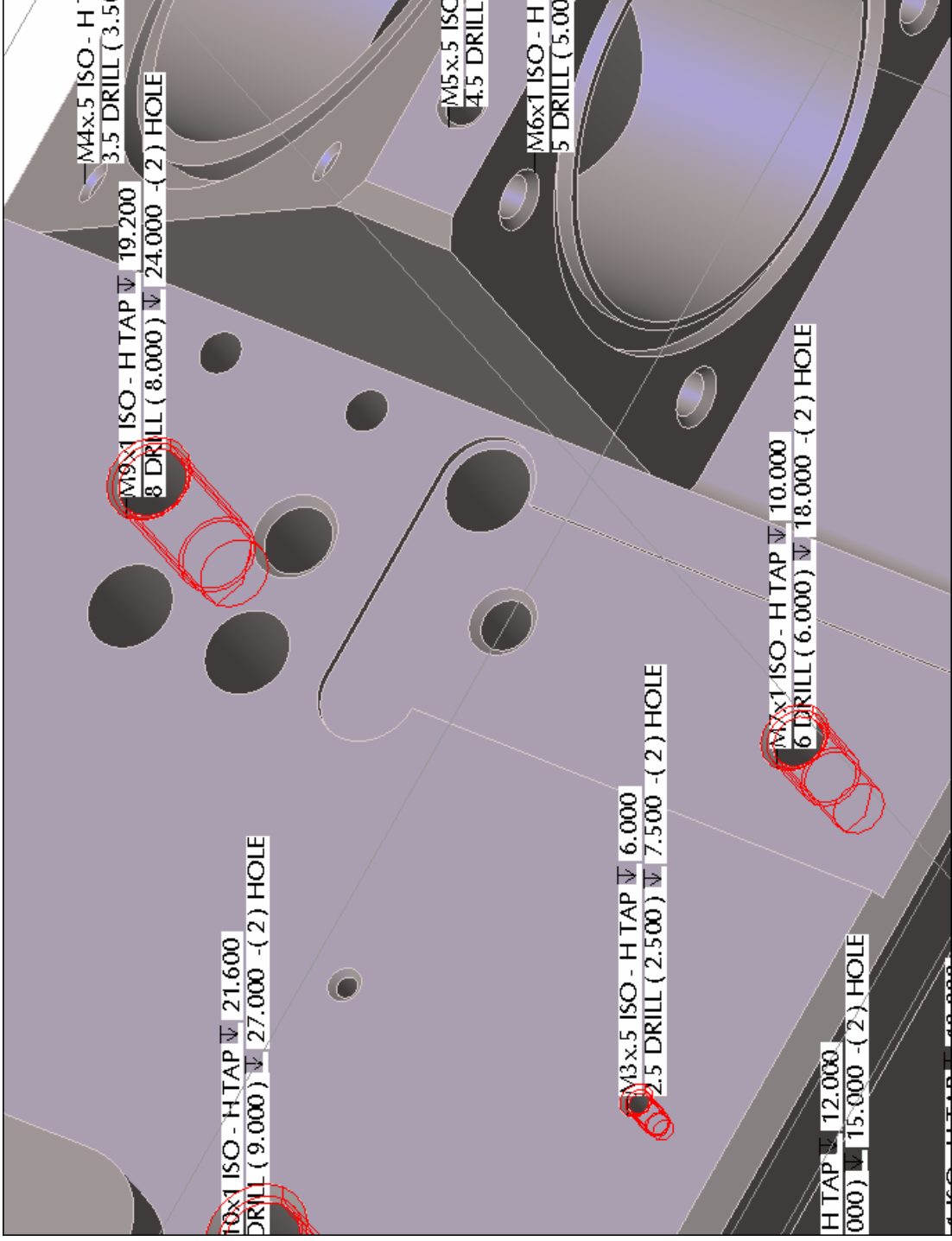

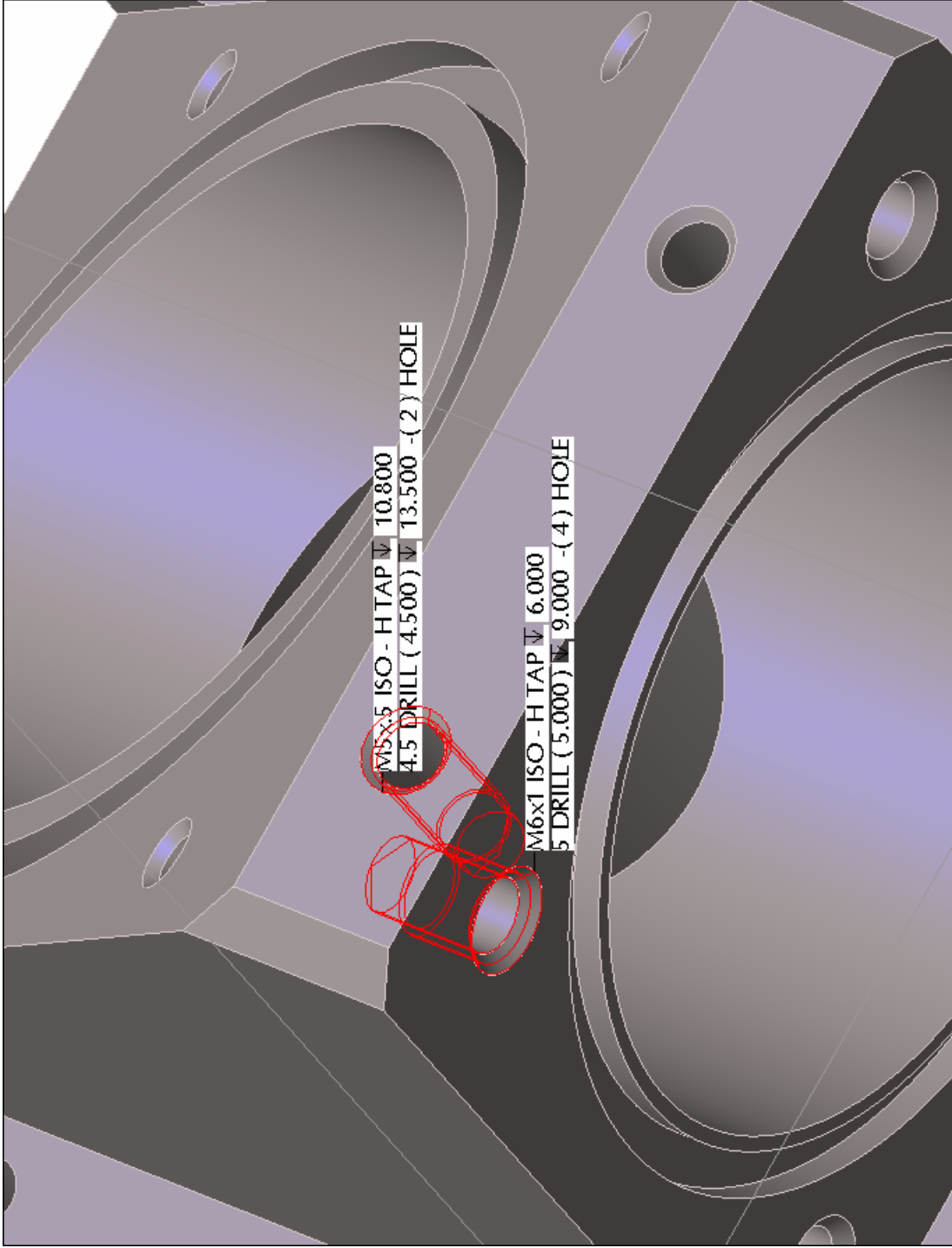

M5x.5 ISO - H TAP ▾ 10.800
4.5 DRILL (4.500) ▾ 13.500 -(2) HOLE

M6x1 ISO - H TAP ▾ 6.000
5 DRILL (5.000) ▾ 9.000 -(4) HOLE

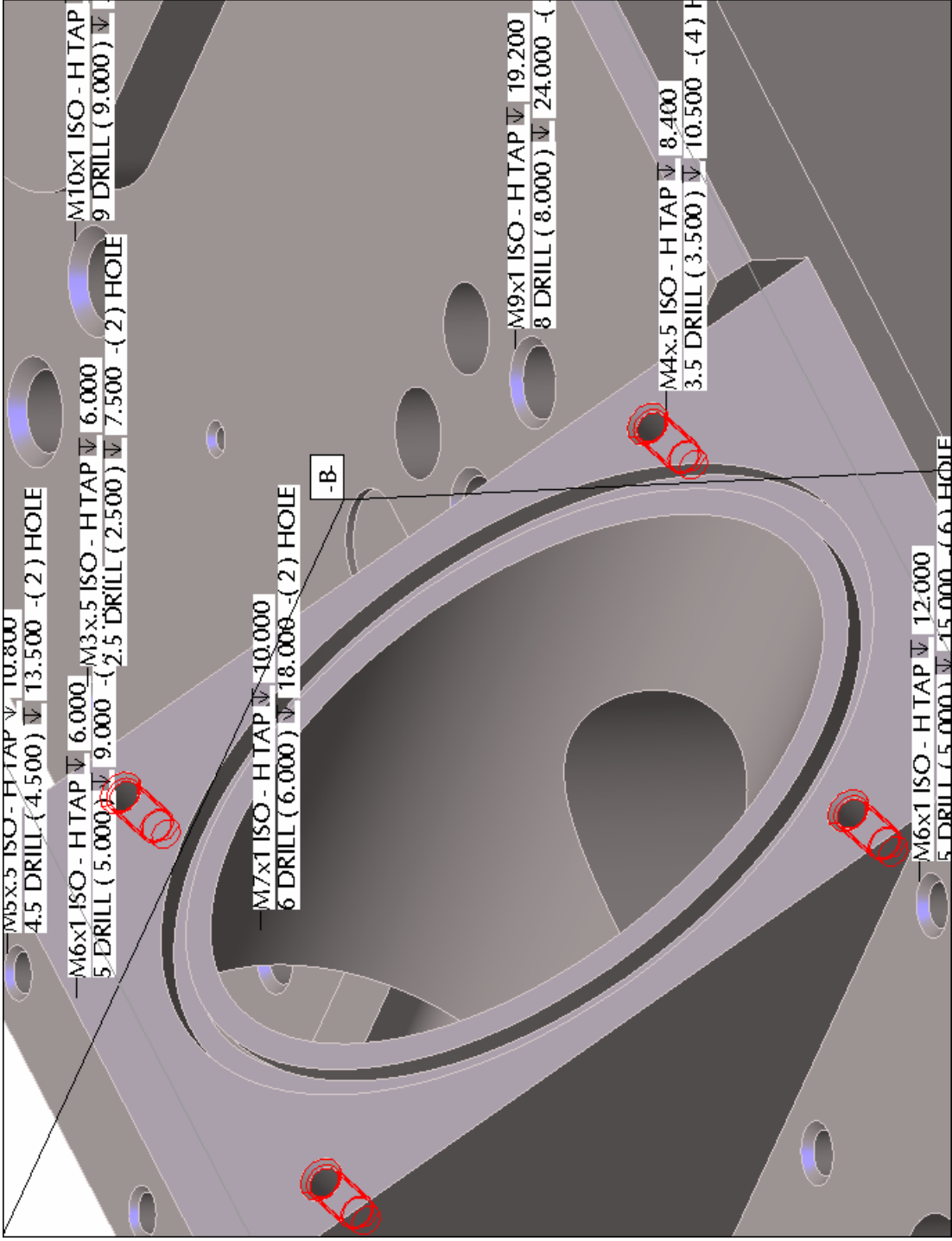

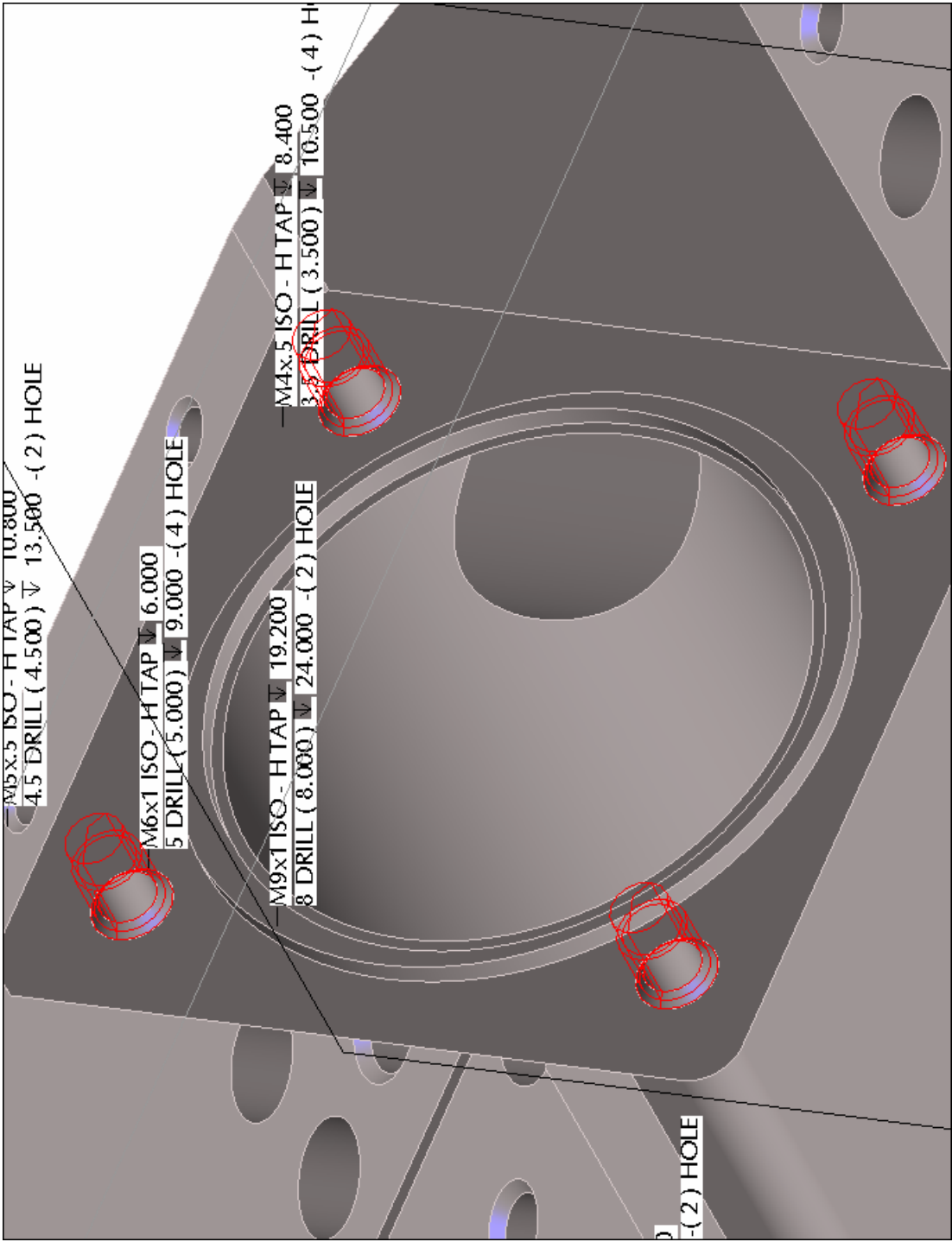

M5x.5 ISO - HTAP 10.800
4.5 DRILL (4.500) 13.500 - (2) HOLE

M6x1 ISO - HTAP 6.000
5 DRILL (5.000) 9.000 - (4) HOLE

M9x1 ISO - HTAP 19.200
8 DRILL (8.000) 24.000 - (2) HOLE

M4x.5 ISO - HTAP 8.400
3.5 DRILL (3.500) 10.500 - (4) H

(2) HOLE